

ZigBee® - Ready RF Transceiver Modules

Product Description

The RC241x and RC241xHP RF Transceiver Modules are a series of compact surface-mounted modules specially designed for the ZigBee® PRO protocol stack. It can also be used for wireless star and mesh networks based on an IEEE 802.15.4 compliant PHY and MAC.

The complete shielded module is only 16.5 x 35.6 x 3.5 mm and comes in both a low-power consuming variant (RC241x) and a High Power version with LNA and power amplifier for extended range (RC241xHP). The two variants are pin compatible. The module is available with integrated antenna or RF connector (U.FL type)

Applications

- Home- and building automation
- Smart Metering / AMR / AMI
 - Electricity, gas, water and heat meters
 - Energy Service Portal (ESP) / Load Control
- IP sensor networks (6LoWPAN)
- Wireless sensor networks



Features

- 100mW / 20 dBm option and low-power option in same packages
- 16.5 x 35.6 x 3.5 mm compact shielded module for SMD mounting
- Integrated antenna option / U.FL connector option
- 256 kB Flash memory, 8 kB SRAM
- 15 digital and analogue I/Os, 8 channel 12 bit ADC
- 2.0 – 3.6 V supply voltage, ultra low power modes
- Optional 4 kB internal EEPROM
- Optional internal SPI flash for over the air upgrade (OTA)
- Conforms with EN 300 440 and EN 300 328 (Europe), FCC CFR 47 part 15 (US), ARIB STD-T66 (Japan) and G.S.R. 542(E)/45(E) (both for India)

Quick Reference Data (typical over manufacturing lots at 3.3V, frequency 2440 MHz)

Parameter	RC241x	RC241xHP	Unit
Frequency band	2.400-2.4835		GHz
Number of channels	16		
Data rate	250		kbit/s
Max output power	4	20*	dBm
Sensitivity (PER 1%)	-97	-99	dBm
Adjacent Channel Rejection	49		dB
Alternate Channel Rejection	57		dB
Supply voltage	2.0 - 3.6	3.0 - 3.6	Volt
Current consumption, RX/TX	24/34	27/175	mA
Current consumption, PD	0.4	10	uA
Flash memory	256		kB
RAM	8		kB
Internal EEPROM (optional)	4		kB
Operating Temperature	-30 to +85 (-40 to +85 available on request)		°C

* Limited to 12 dBm in Europe due to ETSI regulation and limited to 10 dBm in US for frequency 2480MHz due to FCC regulation.

Quick Product Introduction

The RC241x series of modules are specially designed to comply with IEEE 802.15.4-based industry standards like ZigBee PRO, 6LoWPAN, Wireless HART, RF4CE and others. Using the module together with the TI Z-stack is a powerful combination to build any ZigBee profile and application. The module contains qualified RF hardware and enough processor power to run the complete ZigBee mesh network protocol for a full function device including the application.

Using a pre-qualified module is the fastest way to make a ZigBee product and shortest time to market. The embedded RF HW and MCU resources in a 100% RF tested and pre-qualified module shorten the qualification and approval process. No RF design or RF expertise is required to add powerful wireless networking to the product. In most cases you only need supply voltage (for example an external battery) and a sensor/actuator and the module can run the entire application.

The module can be delivered as:

- RC241x/RC241xHP: HW platform. No preloaded firmware.
- RC2411x-ZNM/RC2411HP-ZNM : A complete ZigBee PRO network module where the entire ZigBee PRO compliant stack and configurable application software is preloaded in module and available via a serial API.

Article number and variants:

-AT includes internal chip antenna

-CT include U.FL type connector

For detailed article numbers with various antenna variants, see page (18)

About this document

This document is one part of the documentation for the module. It describes the electrical parameters, RF performance, footprint and PCB layout and regulatory information. Depending on the selected FW solution one additional User Manual should be used. See

- RC24xx/RC24xxHP Firmware Development User Manual for using the module as a hardware platform only
- RC24xx/RC24xxHP-ZNM User Manual for details on how to use the ZNM module with preloaded ZigBee Pro stack and API through a serial interface.

RC24xx/RC24xxHP
Firmware Development User Manual

RC24xx/RC24xxHP-ZNM
User Manual

*Future
User Manuals*

RC241x/RC241xHP Datasheet (This document)

Figure 1 Document structure

Pin Assignment

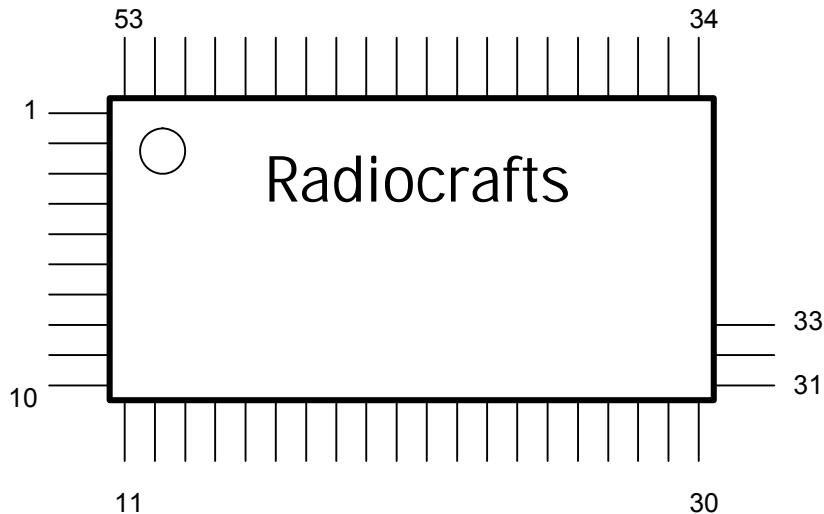

Pin Description

(See User Manual for more detailed pin out)

Pin no	Pin name	Description and internal MCU connection
1	GND	System ground
2	NC	Reserved for future use
3	NC	Reserved for future use
4	GND	System ground
5	I/O pin	Digital I/O
6	I/O pin	Digital I/O
7	I/O pin	Digital I/O
8	I/O pin	Digital I/O
9	I/O pin	Digital I/O
10	GND	System ground
11	GND	System ground
12	I/O pin	Digital I/O, HGM for PA CTRL IN HP VERSION
13	I/O pin	Digital I/O
14	I/O pin	Digital I/O
15	I/O pin	Digital I/O
16	I/O pin	Digital I/O ENABLE(LNA_ENABLE) FOR PA CTRL IN HP VERSION
17	RESET_N	RESET
18	NC	Not connected
19	NC	Not connected
20	NC	Not connected
21	NC	Not connected
22	NC	Not connected
23	NC	Not connected
24	NC	Not connected
25	NC	Not connected
26	NC	Not connected
27	NC	Not connected
28	NC	Not connected
29	NC	Not connected

30	GND	System ground
31	GND	System ground
32	RF_TEST	RF I/O connection for Automatic test purposes. For modules intended for use with U.FL connector, do not connect this pad.
33	GND	System ground
34	GND	System ground
35	VCC	VCC
36	NC	Not connected
37	NC	Not connected
38	NC	Not connected
39	NC	Not connected
40	NC	Not connected
41	SPI_FLASH_RESET	RESET for SPI flash, NC for without SPI flash
42	I/O pin	Digital I/O or Connected to 32kHz crystal
43	I/O pin	Digital I/O or Connected to 32kHz crystal
44	I/O pin	Digital I/O or Programming
45	I/O pin	Digital I/O or Programming
46	I/O pin	Digital I/O
47	I/O pin	Digital I/O
48	I/O pin	Digital I/O
49	I/O pin	Digital I/O
50	I/O pin	Digital I/O
51	I/O, PA enable	Digital I/O, PA ENABLE FOR PA CTRL IN HP VERSION
52	I/O pin	Digital I/O
53	GND	System ground

Block Diagram

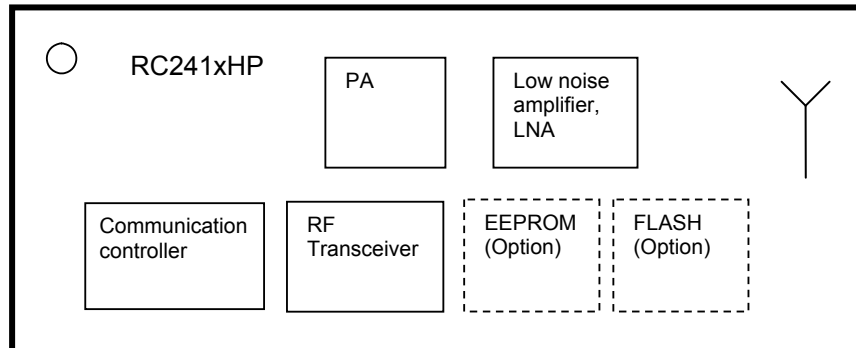

Programming and debugging Interface

For downloading firmware to the module it is required to include a 2x5 pins programming connector to the modules programming pins. The connector should be a 2.54 mm pitch pin-row (same pitch in both directions), SMD or through-hole version, with the following connections:

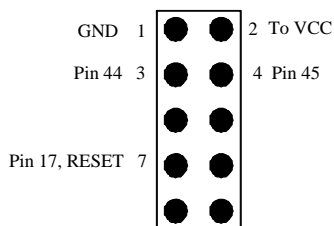

RF Frequency, Output Power Levels and Data Rates

The following table shows the RF channels as defined by the IEEE 802.15.4 standard.

RF channel	Frequency
11	2405 MHz
12	2410 MHz
13	2415 MHz
14	2420 MHz
15	2425 MHz
16	2430 MHz
17	2435 MHz
18	2440 MHz
19	2445 MHz
20	2450 MHz
21	2455 MHz
22	2460 MHz
23	2465 MHz
24	2470 MHz
25	2475 MHz
26	2480 MHz

For proprietary solutions (non-IEEE 802.15.4), the RF transceiver can be programmed in steps of 1 MHz.

The RF transceiver uses direct sequence spread spectrum (DSSS) with 2 Mchip/s chip rate, giving a raw data rate of 250 kbit/s. The modulation format is Offset – Quadrature Phase Shift Keying (O-QPSK). The DSSS makes the communication link robust in noisy environments, which is beneficial when sharing the same frequency band with other applications.

Regulatory Compliance Information

The use of RF frequencies and maximum allowed transmitted RF power is limited by national regulations. The RC241XHP has been designed to comply with world wide regulations (R&TTE directive 1999/5/EC in Europe, G.S.R. 542(E)/45(E) for India and FCC and ARIB). The RC241X (non-HP) complies with all directives and regulations at any power lever setting. In order to comply with the different standards, the output power for RC241XHP should be configured as commented below.

R&TTE directive (EU)

According to R&TTE directive it is the responsibility of Radiocrafts' customers to check that the host product (i.e. final product) is compliant with R&TTE essential requirements. The use of a CE marked radio module can avoid re-certification of the final product, provided that the end user respects the recommendations established by Radiocrafts. A Declaration of Conformity for the modules is available from Radiocrafts on request.

In terms of R&TTE the RC241XHP is a wideband radio and must comply with EN 300 328 on those premises. This implies that the radiated power must be lower than 12 dBm and hence power setting giving 12 dBm or lower can be used in compliance to EN 300 328.

FCC/IC compliance (US, Canada)

This device complies with Part 15 of the FCC Rules and Industry Canada (IC) RSS 210 issue 8.

Part number	FCC ID	IC ID
RC241xAT	Y2NRC24XX	IC 9402A-RC24XX
RC241xCT	Y2NRC24XX	IC 9402A-RC24XX
RC241xHP-AT	Y2NRC24XXHP	IC 9402A-RC24XXHP
RC241xHP-CT	Y2NRC24XXHP	IC 9402A-RC24XXHP

Operation is subject to the following two conditions: (1) this device may not cause harmful interference, and (2) this device must accept any interference received, including interference that may cause undesired operation.

Son fonctionnement est soumis aux deux conditions: (1) cet appareil ne doit pas créer d'interférences nuisibles et (2) cet appareil doit accepter toute interférence reçue, y compris les interférences qui peuvent en perturber le fonctionnement.

Changes or modifications to the equipment not expressly approved by the party responsible for compliance could void the user's authority to operate the equipment.

If an detachable RF connector is introduced in RF path it must be a non-standard type RP-SMA, U.FI etc. The modules have been approved with the following external quarter wave antennas:

Manufacturer	Part number
EAD	Acara
Taoglas	FXP73.07.0100A
Antennova	Titanis

Any use of antenna with gain > 2.5 dBi is strictly forbidden.

Warning for RC241xHP: This is device complies with FCC RF radiation exposure limits set forth for an uncontrolled environment. The antenna used for this transmitter must be installed to provide a separation distance of at least 20 cm from all persons and must not be co-located or operating in conjunction with any other antenna or transmitter. For approval of end product as portable device, separate SAR tests and approval is required for end product.

Avertissement concernant le module RC2400HP: Le module RC2400 HP est conforme à l'exposition aux limites de rayonnements RF FCC acceptées pour un environnement non contrôlé. L'antenne utilisée pour cet émetteur doit être installé pour fournir une distance minimum 20 cm par rapport à toute personne et ne doit pas être à côté ou fonctionner conjointement avec une autre antenne ou transmetteur. Pour l'approbation du produit final en tant que périphérique portable, des tests et homologations SAR propres au produit sont requis.

The output power of RC241x is below the FCC threshold requiring that it be tested for SAR compliance.

La puissance de sortie du RC2400 est inférieur au seuil FCC nécessitant que des tests de conformité SAR soient réalisés.

This device has been designed to operate with an quarter wave antenna having a maximum gain of 2.5 dBi. Antenna having a higher gain is strictly prohibited per regulations of Industry Canada. The required antenna impedance is 50 ohms.

Cet appareil a été conçu pour fonctionner avec une antenne 1/ d'ondes ayant un gain maximum de 2,5 dBi. Utiliser une antenne à gain plus élevé est strictement interdite par les règlements d'Industrie Canada. L'impédance d'antenne requise est de 50 ohms.

To reduce potential radio interference to other users, the antenna type and its gain should be so chosen that the equivalent isotropically radiated power (EIRP) is not more than that required for successful communication.

Pour réduire le risque d'interférence pour les autres utilisateurs, le type d'antenne et son gain doivent être choisies de façon que la puissance isotrope rayonnée équivalente (PIRE) n'est pas supérieure à celle requise pour une communication réussie.

The installer of this radio equipment must ensure that the antenna is located or pointed such that it does not emit RF field in excess of Health Canada limits for the general population; consult Safety Code 6, obtainable from Health Canada's website www.hc-sc.gc.ca/rpb

Le programme d'installation de cet équipement radio doit s'assurer que l'antenne est située ou orientée de façon à ne pas émettre de champ RF dépassant les limites de Santé Canada pour la population en général, consulter le Code de sécurité 6, disponible sur le site Web de Santé Canada www.hc-sc.gc.ca/rpb

End product marking FCC/IC

The end product including the module must include the following text on a visible label:

For RC241x

Contains Transmitter Module FCC ID: Y2NRC24XX/IC: 9402A-RC24XX
Operation is subject to the following two conditions: (1) this device may not cause harmful interference, and (2) this device must accept any interference received, including interference that may cause undesired operation.

Module transmetteur ID IC: 9402A-RC24XX
Son fonctionnement est soumis aux deux conditions suivantes: (1) cet appareil ne doit pas causer d'interférences nuisibles et (2) cet appareil doit accepter toute interférence reçue, y compris les interférences qui peuvent perturber le fonctionnement.

For RC241xHP

Contains Transmitter Module FCC ID: Y2NRC24XXHP/IC: 9402A-RC24XXHP
Operation is subject to the following two conditions: (1) this device may not cause harmful interference, and (2) this device must accept any interference received, including interference that may cause undesired operation.

Module transmetteur ID IC: 9402A-RC24XX
Son fonctionnement est soumis aux deux conditions suivantes: (1) cet appareil ne doit pas causer d'interférences nuisibles et (2) cet appareil doit accepter toute interférence reçue, y compris les interférences qui peuvent perturber le fonctionnement.

WPC compliance (India)

License based operation in India is based on case by case grant and the basis is often a compliance to the R&TTE directive or to FCC.

ARIB compliance

The RC241xHP has been designed to comply with the requirements given by the Japanese ARIB STD-T66 for low power (short range) devices in the 2.4GHz range. However, it has not been formally assessed for conformity with the appropriate regulations. Users must assess and verify that their final product meets the appropriate specifications and to perform the required procedures for regulatory compliance.

The relevant regulations are subject to change. Radiocrafts AS does not take responsibility for the validity and accuracy of the understanding of the regulations referred above.

Radiocrafts only guarantee that this product meets the specifications in this document. Radiocrafts is exempt from any responsibilities related to regulatory compliance.

Antenna and Range Considerations

The module needs an antenna to operate. The following antenna options could be considered.

Antenna	Advantage	Estimated LOS range (meters) RC241X	Estimated LOS range (meters) RC241XHP (100 mW)
Chip antenna -AT	Low cost, easy to implement	200-300	1000-1500
External whip monopole	High performance	500-700	3000-4000
External whip dipole	High performance, no large ground plane required	500-700	3000-4000

When using a module of -CT version with external antenna, the VSWR (Voltage Standing Wave Ratio) of the antenna should be less than 2:1. The VSWR is normally specified in the antenna datasheet and most commercial available antennas fulfil this requirement.

Also note that if the external antenna is a monopole connected with cable, the antenna require a ground plane at base of antenna. Only ground through the cable will not give optimal performance for a monopole antenna.

Antenna parameter for a typical RC2411AT is shown below, for a module with equivalent 4 dBm conducted output power.

Parameter	Result	
Total Radiated Power	-0,91	dBm
Peak EIRP	1,83	dBm
Directivity	2,74	dBi
Efficiency	-4,91	dB
Efficiency	32,28494	%
Gain	-2,17	dBi

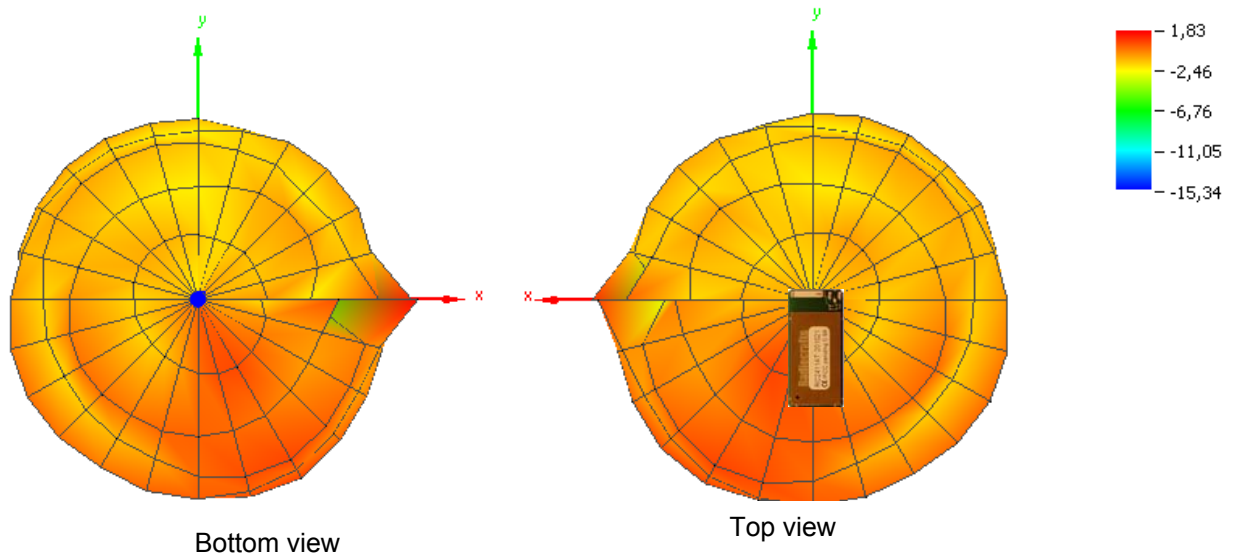

Figure 2 Antenna radiation xy plane

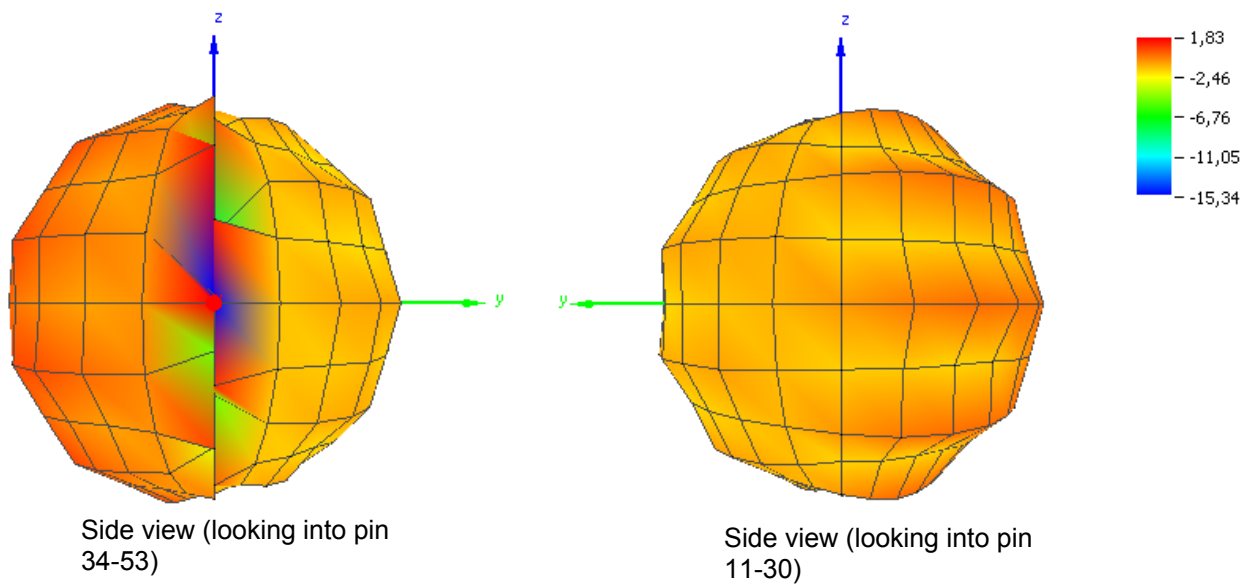

Figure 3. Antenna radiation yz plane

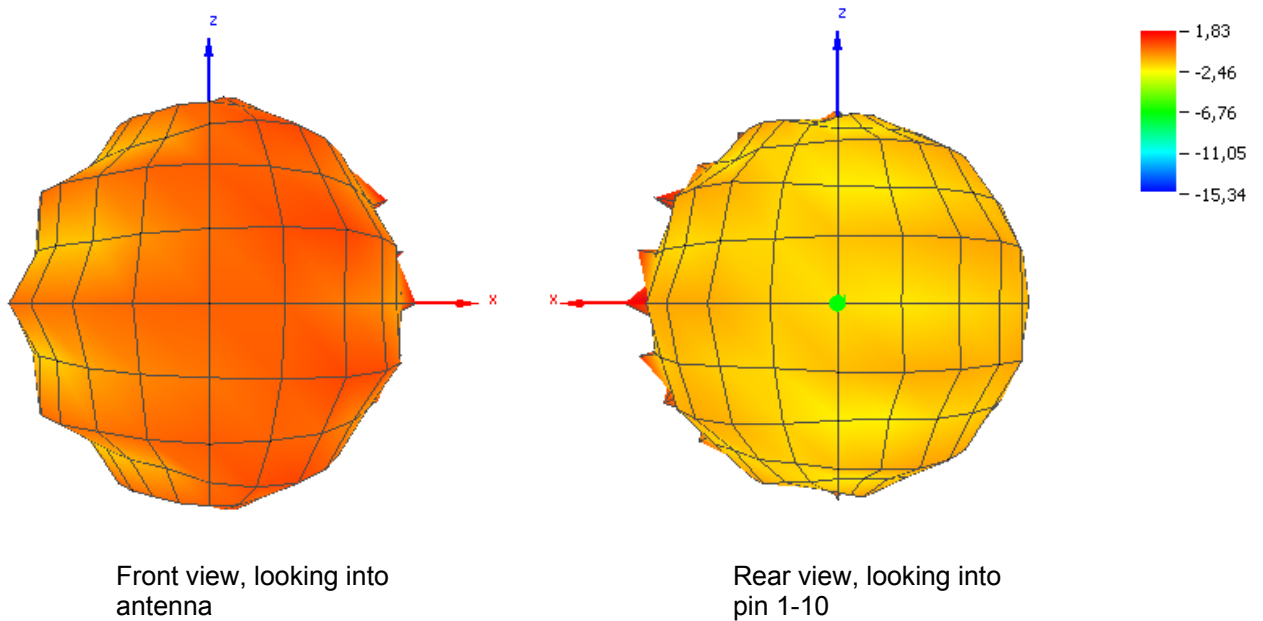

Figure 4. Antenna radiation xz plane

PCB Layout Recommendations

The recommended layout pads for the module are shown in the figure below (top view, pin 1 is in upper left corner). All dimensions are in thousands of an inch (mil). The circle in upper left corner is an orientation mark only, and should not be a part of the copper pattern.

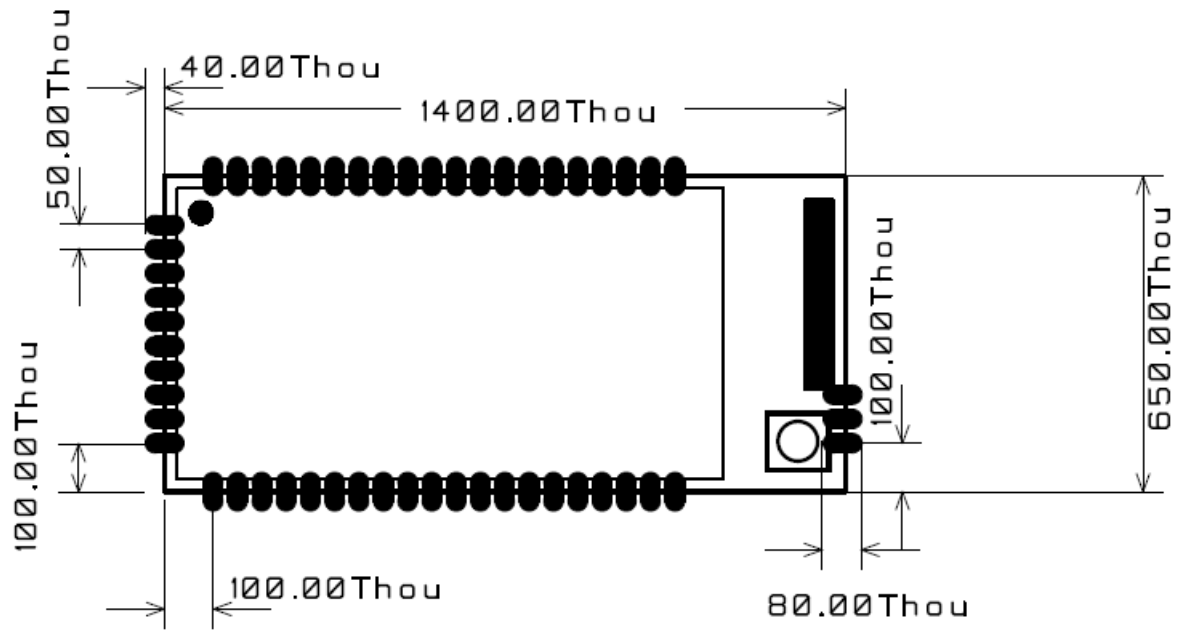

Figure 5 Recommended layout drawing with dimension (all numbers in mil)

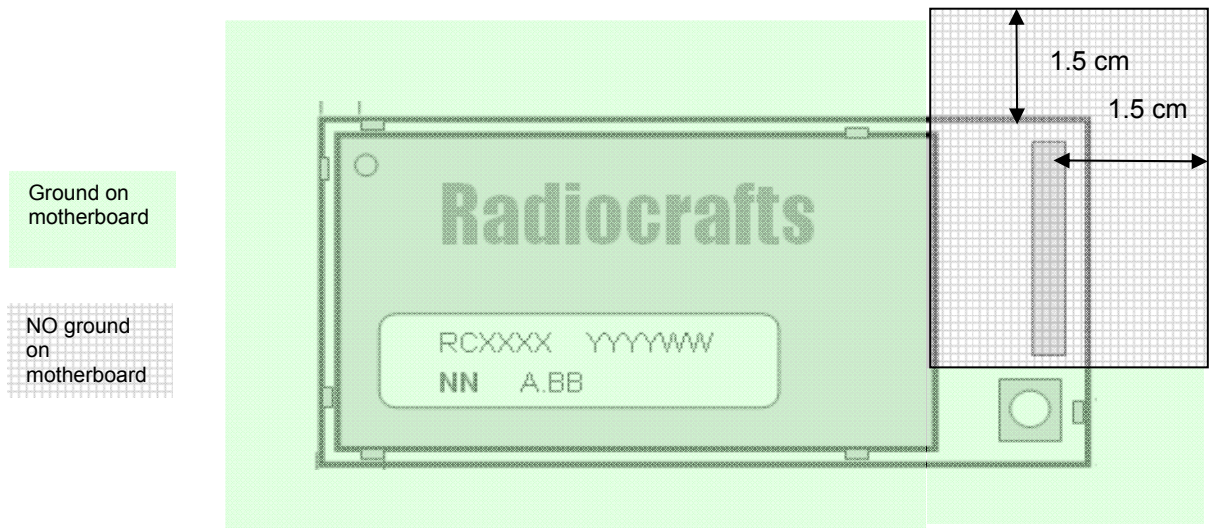

Figure 6 Layout recommendation for variant with chip antenna (-AT)

Proper grounding of all ground pins to ground on motherboard is crucial to get best performance. The ground connection should be made with a via directly from the pad to the ground plane, with shortest possible routing trace.

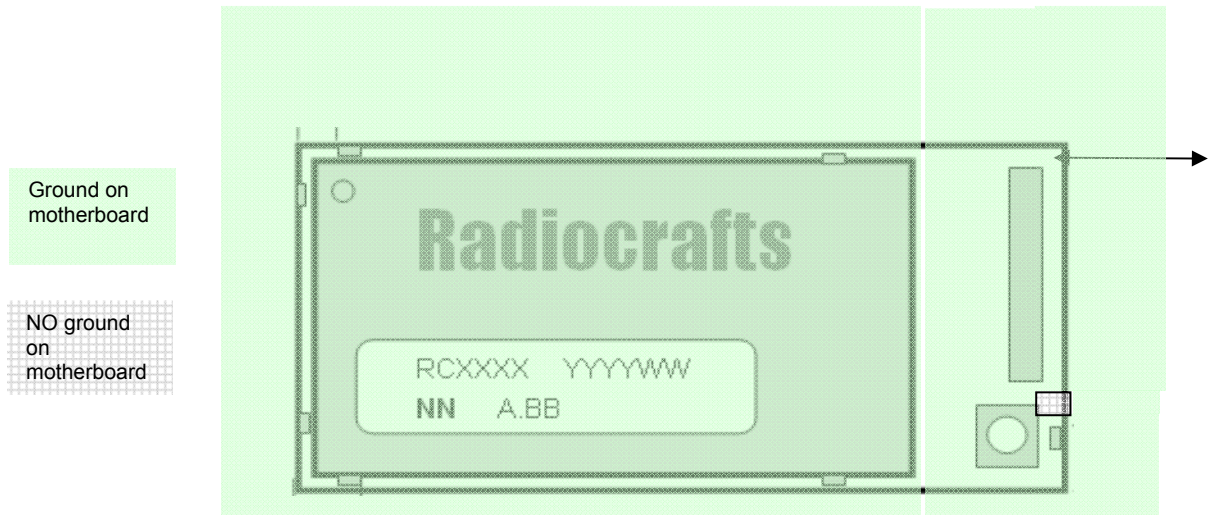

Figure 7 Layout recommendation for variant with U.FL connector.

Removal of ground under RF test pin (Pin 32 on module) to avoid increased capacitance on the RF transmission line is important for optimum performance.

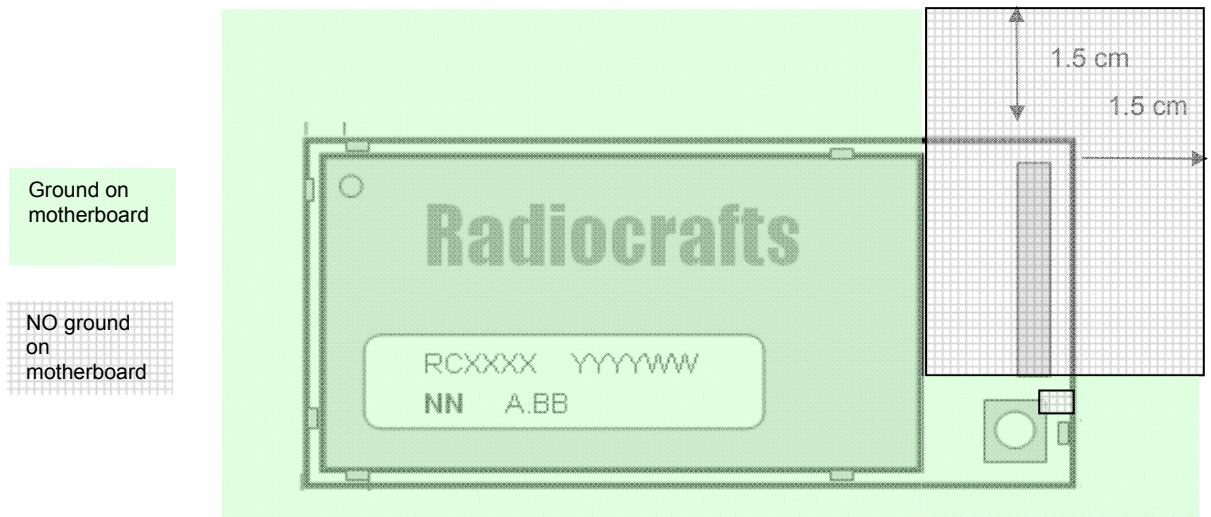

Figure 8. Common layout -AT/-CT

When using –AT version of the module, best range performance is achieved by placing module with chip antenna on corner (A) or edge (B) of carrier-board.

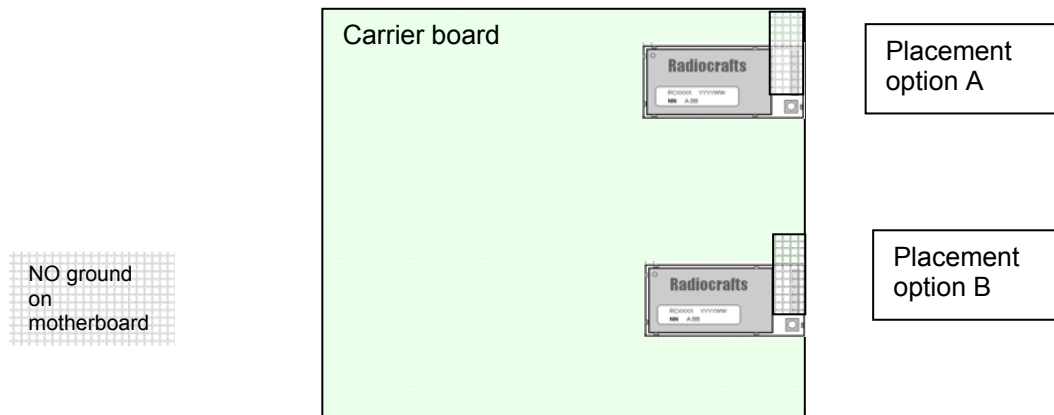
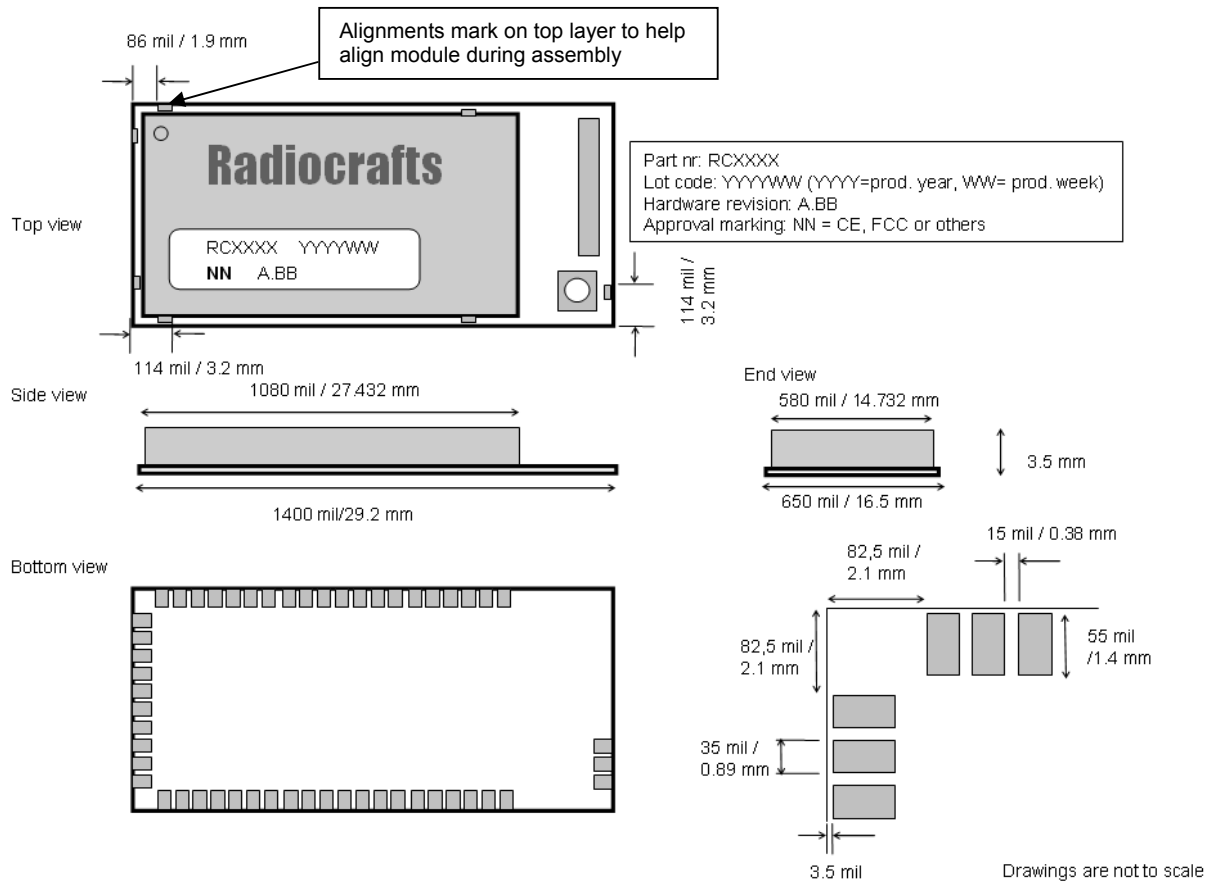

Figure 9. Placement of module on carrier board

Mechanical Drawing



Mechanical Dimensions

The module size is 0.65" x 1.4" x 0.14" (16.5 x 35.6 x 3.5 mm).

Carrier Tape and Reel Specification

Carrier tape and reel is in accordance with EIA Specification 481.

Tape width	Component pitch	Hole pitch	Reel diameter	Units per reel
56 mm	20 mm	4 mm	13"	Max 800

Note that the Radiocrafts technical support team is available for free-of-charge schematic and layout review of your design.

Soldering Profile Recommendation

JEDEC standard IPC/JEDEC J-STD-020D.1 (page 7 and 8), Pb-Free Assembly is recommended.

The standard requires that the heat dissipated in the "surroundings" on the PCB is taken into account. The peak temperature should be adjusted so that it is within the window specified in the standard for the actual motherboard.

Aperture for paste stencil is normally areal-reduced by 20-35%, please consult your production facility for best experience aperture reduction. Nominal stencil thickness of 0.1-0.12 mm recommended.

Absolute Maximum Ratings

Parameter	Min	Max	Unit
Supply voltage, VCC	-0.3	3.6	V
Voltage on any pin	-0.3	VCC+0.5	V
Input RF level		10	dBm
Storage temperature	-40	85	°C
Operating temperature	-30	85	°C

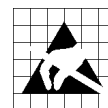

Caution ! ESD sensitive device.
Precaution should be used when handling the device in order to prevent permanent damage.

Under no circumstances the absolute maximum ratings given above should be violated. Stress exceeding one or more of the limiting values may cause permanent damage to the device.

Electrical Specifications

T=25°C, VCC = 3.3V, 50 ohm if nothing else stated.

Parameter	Min	Typ.	Max	Unit	Condition / Note
Operating frequency	2400		2483	MHz	Programmable in 1 MHz steps, 5 MHz steps for IEEE 802.15.4 compliance
Number of channels		16			For IEEE 802.15.4 compliance
Channel spacing		5		MHz	For IEEE 802.15.4 compliance
Input/output impedance		50		Ohm	
Data rate		250		kbit/s	
DSSS chip rate		2		Mc/s	
Frequency stability			+/-40	ppm	With 10 year aging
Transmit power RC241x RC241xHP	-23 -6		4 20	dBm	Programmable from firmware
Harmonics RC241X 2 nd harmonic 3 rd harmonic RC241XHP (20 dBm Pout) 2 nd harmonic 3 rd harmonic		-50 -70 -48 -50	-45 -45		Measured according to FCC CRF47 Part 15
Spurious emission RC241xHP, TX, 20 dBm 30 – 1000 MHz 1-12.75 GHz			-50 -45	dBm	Complies with EN 300 328, EN 300 440, FCC CRF47 Part 15 and ARIB STD-T66

Parameter	Min	Typ.	Max	Unit	Condition / Note
RC241x TX, 4 dBm 30 – 1000 MHz 1-12.75 GHz 1.8-1.9 GHz 5.15-5.3 GHz			-56 -48 -53 -60		
Sensitivity RC241x RC241xHP		-97 -99		dBm	PER = 1%
Adjacent channel rejection +/- 5 MHz		49		dB	At -82 dBm, PER = 1%. 0 dB for IEEE 802.15.4 compliance
Alternate channel selectivity +/- 10 MHz		57		dB	At -82 dBm, PER = 1%. 30 dB for IEEE 802.15.4 compliance
Saturation		10		dBm	
Spurious emission, RX 30 -1000 MHz 1-12.75 GHz			-57 -47	dBm	Complies with EN 300 328, EN 300 440, FCC CRF47 Part 15 and ARIB STD-T66
Supply voltage RC241x RC241xHP	2.0 3.0		3.6 3.6	V	
Current consumption, RX RC241x RC241xHP		24 27		mA	MCU in Idle mode using the 32 MHz oscillator.
Current consumption, TX RC241x, 4dBm RC241xHP, 20 dBm		34 200		mA	MCU in Idle mode using the 32 MHz oscillator.
Current consumption, Power down, power mode 3 RC2411AT RC2411HP-CT		0.4 10		µA	Wake-up time to power mode 0 is 54 µS
RAM memory		8		kB	
MCU clock frequency		32		MHz	
MCU low frequency crystal		32.768		kHz	
Antenna VSWR		<2:1	3:1		Requirement for external antenna

Variant MATRIX

-AT includes internal chip antenna

-CT include U.FL type connector

Ordering Part Number	RC2412AT	RC2411AT	RC2412CT	RC2411CT	RC2412HP-AT	RC2411HP-AT	RC2412HP-CT	RC2411HP-CT
High power amplifier (20 dBm)					•	•	•	•
SPI flash (OTA) 256 kB	On Request							
32 kHz RTC (XO)	•		•		•		•	
I2C EEPROM	On Request							
Chip antenna	•	•			•			
U.FL connector			•	•			•	•



Document Revision History

Document Revision	Changes
1.0	First release
1.1	Updated with FCC information. Status changed to Full Production
1.2	Corrected minor misprint. Minor changes.

Product Status and Definitions

Current Status	Data Sheet Identification	Product Status	Definition
	Advance Information	Planned or under development	This data sheet contains the design specifications for product development. Specifications may change in any manner without notice.
	Preliminary	Engineering Samples and First Production	This data sheet contains preliminary data, and supplementary data will be published at a later date. Radiocrafts reserves the right to make changes at any time without notice in order to improve design and supply the best possible product.
X	No Identification Noted	Full Production	This data sheet contains final specifications. Radiocrafts reserves the right to make changes at any time without notice in order to improve design and supply the best possible product.
	Not recommended for new designs	Last time buy available	Product close to end of lifetime
	Obsolete	Not in Production Optionally accepting order with Minimum Order Quantity	This data sheet contains specifications on a product that has been discontinued by Radiocrafts. The data sheet is printed for reference information only.

Disclaimer

Radiocrafts AS believes the information contained herein is correct and accurate at the time of this printing. However, Radiocrafts AS reserves the right to make changes to this product without notice. Radiocrafts AS does not assume any responsibility for the use of the described product; neither does it convey any license under its patent rights, or the rights of others. The latest updates are available at the Radiocrafts website or by contacting Radiocrafts directly.

As far as possible, major changes of product specifications and functionality, will be stated in product specific Errata Notes published at the Radiocrafts website. Customers are encouraged to check regularly for the most recent updates on products and support tools.

Trademarks

ZigBee®™ is a registered trademark of the ZigBee Alliance.

All other trademarks, registered trademarks and product names are the sole property of their respective owners.

Life Support Policy

This Radiocrafts product is not designed for use in life support appliances, devices, or other systems where malfunction can reasonably be expected to result in significant personal injury to the user, or as a critical component in any life support device or system whose failure to perform can be reasonably expected to cause the failure of the life support device or system, or to affect its safety or effectiveness. Radiocrafts AS customers using or selling these products for use in such applications do so at their own risk and agree to fully indemnify Radiocrafts AS for any damages resulting from any improper use or sale.

© 2011, Radiocrafts AS. All rights reserved.

Contact Information

Web site: www.radiocrafts.com

Email: radiocrafts@radiocrafts.com

Address:

Radiocrafts AS
Sandakerveien 64
NO-0484 OSLO
NORWAY

Tel: +47 4000 5195

Fax: +47 22 71 29 15

E-mail: sales@radiocrafts.com

support@radiocrafts.com